

MITEL

SX-200 IP Communications Platform

5330 IP and 5340 IP Phones
User Guide



NOTICE

The information contained in this document is believed to be accurate in all respects but is not warranted by Mitel Networks™ Corporation (MITEL®). The information is subject to change without notice and should not be construed in any way as a commitment by Mitel or any of its affiliates or subsidiaries. Mitel and its affiliates and subsidiaries assume no responsibility for any errors or omissions in this document. Revisions of this document or new editions of it may be issued to incorporate such changes.

No part of this document can be reproduced or transmitted in any form or by any means - electronic or mechanical - for any purpose without written permission from Mitel Networks Corporation.

TRADEMARKS

Mitel is a trademark of Mitel Networks Corporation.

Windows and Microsoft are trademarks of Microsoft Corporation.

Other product names mentioned in this document may be trademarks of their respective companies and are hereby acknowledged.

Mitel 5330 IP and 5340 IP Phones - User Guide

April 2008

®,™ Trademark of Mitel Networks Corporation
© Copyright 2008, Mitel Networks Corporation
All rights reserved

TABLE OF CONTENTS

ABOUT YOUR PHONE	1
Ring/Message Indicators.....	3
Tips For Your Comfort And Safety.....	4
Don't cradle the handset!	4
Protect your hearing.....	4
Adjust the viewing angle.....	4
Using Your Default Phone Window And Keys	5
Getting Started with Your Phone.....	5
USING YOUR PHONE APPLICATIONS.....	7
Using the Settings Application	7
Customizing Your Phone	8
Using the Dial Pad to Enter Information.....	8
Using the Onscreen Keyboard to Enter Information	8
Specify User Information.....	9
Specify Language.....	9
Specify Display Brightness and Contrast.....	9
Specify Audio Feedback Options.....	10
Specify Text Size.....	10
Adjust Ringer Volume and Pitch	11
Enable a Screen Saver	12
Programming Features On Your Keys.....	13
Program Feature Keys Using the Settings Application	15
Edit Key Labels	15
Clear Programming from a Key.....	15
Program Superkey to a Key	16
To program Speed Call	16
Programming Applications on Your Keys	17
Making And Answering Calls	18
Using the People Application	18
Phone Book.....	19
Answer a call.....	19
End a call.....	19
Redial	19
Handsfree Operation	19
Auto Answer	20
Call Handling	21
Hold.....	21
Mute.....	21
Transfer	21

Conference.....	22
Swap.....	22
Call Forwarding	22
Using Other Features	23
Account Codes	23
ACD.....	23
Attendant Call Hold - Remote Retrieve.....	23
Auto Latch Microphone	24
Callback.....	24
Call Forward - Remote (I Am Here)	24
Call Logging (Call History).....	25
Call Park.....	26
Call Pickup	26
Campon.....	27
Direct Paging.....	27
Do Not Disturb.....	29
Group Listen.....	29
Group Paging / Meet Me Answer	30
Headset Operation	30
Make Busy.....	31
Messaging - Advisory	31
Messaging - Callback.....	31
Messaging - Cancel Callback.....	32
Music	32
Night Answer	32
Override (Intrude).....	33
Paging	33
Record a Call.....	33
Reminder.....	34
Speed Call.....	34
Trunk Flash	35
Using Your Phone With The 5310 IP Conference Unit.....	35
Access the Conference Controller	35
Turn the conference unit on and off	35
Adjust the conference unit volume	35
Place the conference unit in Presentation mode	35
Exit the conference controller.....	35
Mute the conference unit.....	35
USING YOUR PHONE WITH CORDLESS MODULE & ACCESSORIES	36
Handset/Headset Combinations	38
Pairing the Cordless Module and Accessories.....	38
Cordless Module LED Indicators.....	39
Using the Cordless Handset	40

Elements of the Cordless Handset.....	40
Answer a call	41
Hang up.....	41
Dialing – Auto Dial Disabled.....	41
Dialing – Auto Dial Enabled	41
Alerting Tones and LEDs	41
Checking Battery Level of Cordless Accessories	42
Replacing Batteries in Cordless Accessories.....	42
Viewing Cordless Accessory Information.....	42
Using the Cordless Headset	43
Answer a call	44
Hang up.....	44
Dialing – Auto Dial Disabled.....	44
Dialing – Auto Dial Enabled	44
Headset Alerting Tones and LEDs.....	44
Checking Battery Level of Cordless Accessories	45
Replacing Batteries in Cordless Accessories.....	45
Viewing Cordless Accessory Information.....	45
Using the Cordless Devices Application	46
Viewing Cordless Module Information.....	46
Low Battery Level.....	46
Auto Dial	46
Using a Cordless Device as a Remote Control.....	47

ABOUT YOUR PHONE

The Mitel® 5330 and 5340 IP Phones are full-feature, dual port, dual mode enterprise-class telephones that provide voice communication over an IP network. They both feature a large graphics display (160 x 320) and self-labeling keys. The 5330 IP Phone offers 24 programmable multi-function keys, and the 5340 IP Phone offers 48 programmable multi-function keys for one-touch feature access. Both phones provide ten fixed feature keys for convenient access to features such as Conferencing, Redial, and many customizable user settings as well as navigational keys to access various screens and application layers.

The 5330 and 5340 IP Phones support Mitel Call Control (MiNet) protocol and session initiated protocols (SIP). Both phones support the 5310 IP Conference Unit. The 5330/5340 phones are ideal for executives and managers, and can be used as an ACD Agent or Supervisor Phone, as well as a Teleworker Phone.





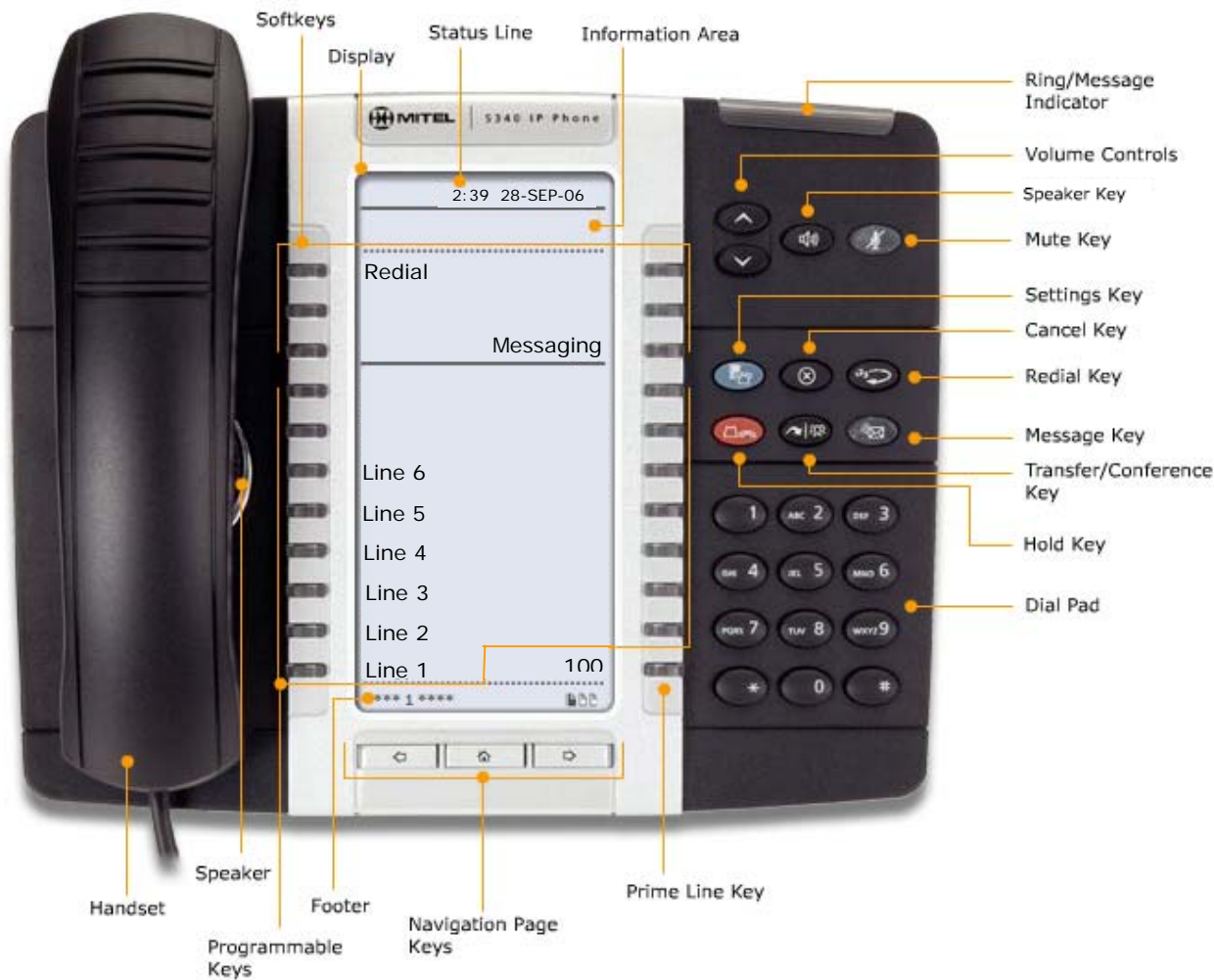



The 5330 IP Phone



The 5340 IP Phone

Elements of Your Phone

Feature	Function
Display	Provides a large, high-resolution viewing area that assists you in selecting and using phone features.
Ring/Message Indicator	Flashes to signal an incoming call and to indicate a message waiting in your voice mailbox.
Volume, Speaker and Mute Controls	Provide the following audio control capability: ▲ (UP) and ▼ (DOWN) provide volume control for the ringer, handset, and handsfree speakers. 🔊 (SPEAKER) enables and disables Handsfree mode. 🚫 (MUTE) enables Mute, which allows you to temporarily turn your phone's handset, headset or handsfree microphone off during a call.

Feature	Function
Fixed Function Keys	<p>Give you access to the following phone functions:</p> <p> (SETTINGS) : provides access to menus for your phone's additional features.</p> <p> (CANCEL) : ends a call when pressed during the call, and, when you are programming the phone, eliminates any input and returns to the previous menu level.</p> <p> (REDIAL) : calls the last number dialed.</p> <p> (HOLD) : places the current call on hold.</p> <p> (TRANS/CONF) : initiates a call transfer or establishes a three-party conference call.</p> <p> (MESSAGE) : provides access to your voice mailbox and flashes to notify you of messages waiting in your voice mailbox. Note : The Ring/Message indicator also flashes when messages are waiting.</p>
Keypad	Use to dial.
Navigation Page Keys	Use to display additional pages of information. The 5330 has two page navigation keys: Back and Next. The 5340 has three page navigation keys: Back, Next, and Home.
Programmable Feature Keys and Softkeys.	Provides 24 (on the 5330) and 48 (on the 5340) self-labeling keys that can be programmed as speed call keys, fixed function keys, applications, or line appearance keys, according to your communication needs On your home page, the bottom right feature key is always your Prime Line key on a 5340 IP Phone; and the bottom left feature key is always your Prime Line key on the 5330 IP Phone. The top three keys are softkeys.
Handsfree Speaker	Provides sound for Handsfree calls and background music.
Handset	Use for handset calls. If you are in headset or handsfree mode, you do not need to use the handset.

Ring/Message Indicators

When indicator is ...	it means that ...
Flashing rapidly	Your phone is ringing
Flashing slowly	A message or callback message is waiting at your phone
On	Your phone is ringing another phone
Off	Your phone is idle, or you are on a call

Tips For Your Comfort And Safety

Don't cradle the handset!

Prolonged use of the handset can lead to neck, shoulder, or back discomfort, especially if you cradle the handset between your ear and shoulder. If you use your phone a lot, you may find it more comfortable to use a headset. See the section on headset usage elsewhere in this guide for more information.

Protect your hearing

Your phone has a control for adjusting the volume of the handset receiver or headset. Because continuous exposure to loud sounds can contribute to hearing loss, keep the volume at a moderate level.

Adjust the viewing angle

The stand built into your phone tilts to give you a better view of the keys.

To tilt your telephone for better viewing:

1. Turn the phone so that the front faces away from you.
2. Hold the base unit firmly and press the release tabs on the sides of the stand to detach the base unit.
3. Hinge the hooks of the base unit into the notches on the back of the phone and snap into place as follows:
 - a) For a high-angle mount, hinge the two lower hooks into the bottom set of notches and snap the two upper hooks into the middle set of notches.
 - b) For a low-angle mount, hinge the two lower hooks into the middle set of notches and snap the two upper hooks into the top set of notches.

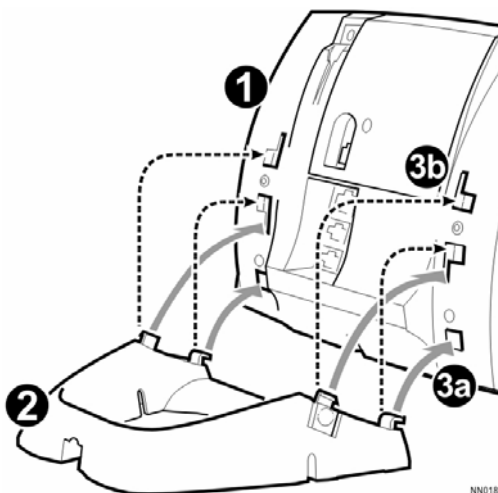

NN0183

Using Your Default Phone Window And Keys

The 5340 and 5330 IP Phone default phone windows and keys are shown and described below. The Phone window provides access to programmable keys and the main phone interface.



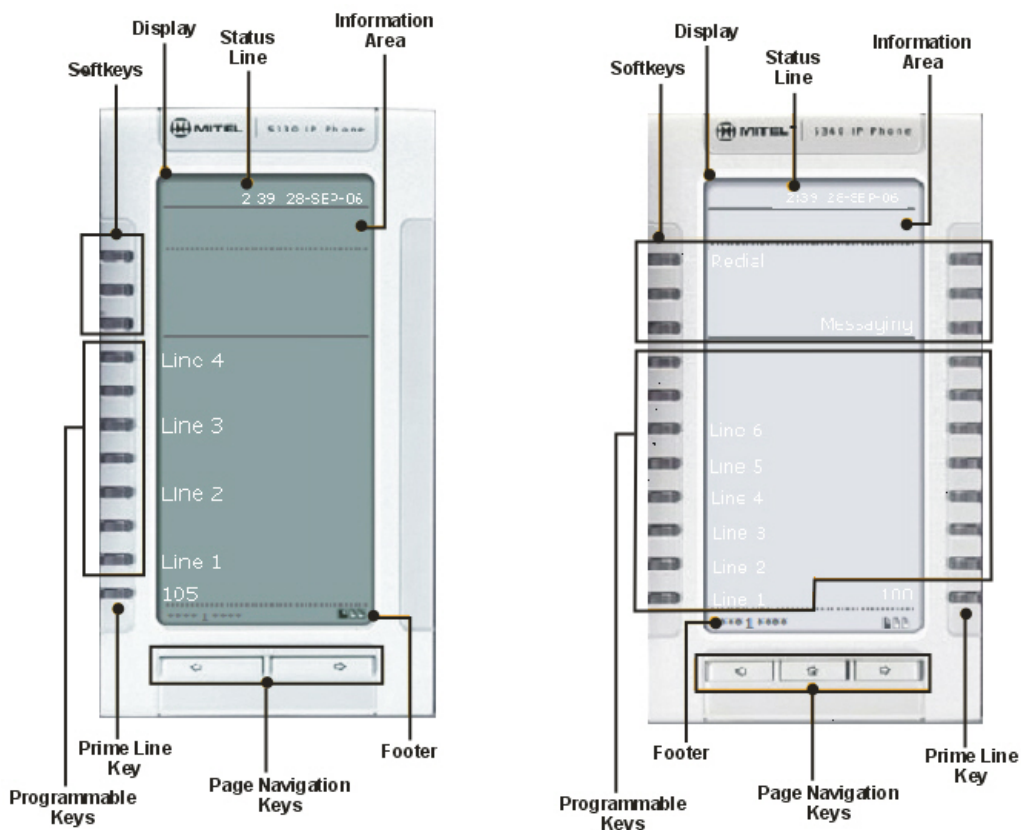

Getting Started with Your Phone

When you receive your phone, you need to program features and applications.



5330 and 5340 IP Phone Windows

5330 and 5340 IP Phone Default Window and Keys

Feature	Function
Softkeys	Allow you to access specific call control features, which are context sensitive. These are non-programmable feature keys that are specific to the application or state of the set. The 5330 provides three softkeys and the 5340 provides six softkeys.
Programmable Keys	Launch specific call control features. Use the <i>Settings</i> application or a programmed Superkey to program these keys. The 5340 provides 16 programmable keys per page (a maximum of 47 programmable keys plus 1 prime line key). The 5330 provides 8 per page (a maximum of 23 programmable keys plus 1 prime line key). For instructions on programming the keys, see Programming Features on Your Keys .
Page Navigation Keys	Display additional pages of information. The 5330 has two page navigation keys: Back and Next , while the 5340 has three page navigation keys: Back , Next , and Home .
Status Line	Displays time, date, and icons indicating feature states as follows: Message Waiting () - Indicates new voice mail. Headset () - Indicates that the phone is in headset mode. DND () - Indicates DND (Do not disturb) mode. Logged in as () - Indicates that a hot desk user is logged in. Conference Unit () - Indicates that the Conference Unit is connected and turned on.
Information Area	Provides prompts in most phone applications. Content changes based on the application.
Footer	Shows context and summary information based on information in the Programmable Keys area, such as Page Indicators and numbers of items.

USING YOUR PHONE APPLICATIONS

Your 5330 and 5340 IP Phones provide applications and settings that simplify the use of your phone. The *Applications* window provides access to all the phone's applications.

To open an application, press the key beside the application name:

- **Applications List:** Provides an onscreen access list of the applications available on your phone. For information about programming Applications, see [Programming Applications on Your Keys](#) on page 17.
- **People (5340 IP Phone only):** Use the *People* application to add, edit, or delete contact names and numbers. You can also dial anyone on your contact list from the *People* applications. Contacts are displayed alphabetically by last name. For more information about using the *People* application, refer to [Using the People Application](#) on page 18.
- **Conference Unit:** Use the *Conference Unit* application to control the 5310 IP Conference Unit. Use this application to turn the conference unit off or on, to adjust the volume, or to put the conference unit into Presentation mode. You can only run one Conference Controller session at a time. The *Conference Unit* application is available only when your phone is connected to a 5310 Conference Unit. See [Using Your Phone with the 5310 Conference Unit](#) on page 35 for more information.
- **Settings:** Use the *Settings* application to display and quickly change your phone's current communications settings. See [Using the Settings Application](#) on this page for more information.
- **Cordless Devices:** Use the Cordless Module application to configure and view status of cordless accessories. See [Using the Cordless Module](#) for more information.
- **Help:** Provides access to Quick Help and defines all keyboard icons.

You can access phone Applications by programming an Applications feature key. For information about programming keys, see [Programming Feature Keys Using the Settings Key](#) on page 13.

Using the Settings Application

The *Settings* application provides a location to access most phone settings. You can also launch the *Settings* application and open the Settings window by pressing the **Settings** fixed function key . Select any option in the window to access another window where you can view and configure the phone settings for that option. Press the page navigation keys to see the next page of options.

The Settings window provides the following options:

- **User Information:** For Release 4.0 of the SX-200 ICP, number information must be programmed by your System Administrator. (For information about editing names, see [Specify User Information](#) on page 9.)
- **Programmable Keys:** Use this option to assign features to the programmable keys on your phone. For a list of available features, see page 13.
- **Languages:** Allows you to select the language in which phone prompts and applications appear. Supported languages are English, French, and Spanish.
- **Text Size:** Allows you to specify the font size (large or small) for the 5340 IP Phone.
- **Brightness and Contrast:** Allows you to adjust the display brightness and contrast of your phone.

- **Screen Saver:** Allows you to specify a specific time of inactivity on your phone that triggers the screen saver to display.
- **Audio Feedback:** This setting allows you to adjust the volume of the audio feedback and the error beeps as well as enable or disable the setting.
- **About 5330/5340 IP Phone:** This screen displays firmware release information.

Customizing Your Phone



Using the Dial Pad to Enter Information

You can use the standard dial pad keys 0-9, and * and # to enter a name and or number for applications and features. Using the dial pad is the default option. You can also use the onscreen keyboard by selecting **Keyboard** while entering text (see [Using the Onscreen Keyboard](#)).

The following table shows the characters you can enter by pressing a key consecutively. For example, to enter the letter “e”, press the ‘3’ key twice.

Key	Characters								
1	1								
2	a	b	c	A	B	C	2		
3	d	e	f	D	E	F	3		
4	g	h	i	G	H	I	4		
5	j	k	l	J	K	L	5		
6	m	n	o	M	N	O	6		
7	p	q	r	s	P	Q	R	S	7
8	t	u	v	T	U	V	8		
9	w	x	y	z	W	X	Y	Z	9
0	0								
*	*	Space							
		..							
#	#	.	,	()	+			

Characters are automatically inserted after a one-second delay. If you make an error, use **Backspace** (or **Clear** on the 5340) to make corrections.



Press  or  at the bottom of the set to move the cursor forwards or backwards without deleting characters.

Note: When a text entry window is open, you cannot use the dial pad for dialing.

Using the Onscreen Keyboard to Enter Information

The onscreen keyboard can be used to enter name and number information into applications and features:

1. When prompted to enter name/number information, press **Keyboard** to display the onscreen keyboard.
2. Press **Next Page** and **Previous Page** to navigate to the set of characters needed for your input.
3. Repeatedly press the key next to the character you want to enter until that character is highlighted. The character is automatically inserted after a one-second delay. If you make

an error, press  or  at the bottom of the set to move the cursor backwards or forwards. This does not delete any characters. You can press **Backspace** (or **Clear** on the 5340) to delete characters.

4. After you have entered all the characters, press **Save**.
5. Continue with text entry as required by the application, or press **Close**.

Specify User Information

To specify the number displayed on the phone, see your Administrator.

To edit the name displayed on the phone:

1. Press **Settings** or .
2. Press **User Information**.
3. Press **Edit Name**.
4. Use the [dial pad](#) or the [onscreen keyboard](#) to spell your name.
5. Press **Save** and then press **Save** again.

Note: Changing the name displayed on your phone changes the following items throughout the system:

- call display that is displayed to your callers
- BLF keys
- mailbox keys
- key line appearance keys

Specify Language

To specify the language in which prompts and applications display:

1. Press **Settings** or .
2. Press **Languages**.
3. Select a language and then press **Save**.

Note: Languages supported on the 5330/5340 may differ from those supported on the ICP. If the phone is configured for an unsupported language, the prompts may appear in your selected language but the language of the Application page defaults to English. The Language window displays "<name of the selected language> Unsupported".

Specify Display Brightness and Contrast

You can adjust the brightness and display contrast either via the phone volume controls (when the phone is idle) or via the *Settings* application. (On a 5330 IP Phone, you can only adjust the contrast, not the brightness.)

To adjust the display contrast using the volume controls:

- Repeatedly press  (UP) or  (DOWN).

Note: You can use this method only when the phone is idle. If the phone is ringing, this action adjusts the ring volume. If the phone is in use, this action adjusts the handset, headset and speakerphone volume.

To adjust the display brightness and contrast using the *Settings* application:

1. Press **Settings** or .
2. Press **Brightness and Contrast**.
3. Press the Brightness and Contrast '+' or '-' keys to adjust the brightness and contrast of your screen.
4. Press **Save**.

Note: Press **Cancel** at any time to exit this application without making any changes.

Note: If you replace an existing 5330/40 IP phone with a Rev C or higher version using the same Directory Number, the initial display will not have optimum settings. Follow the instructions above to set the brightness to the desired level.

Specify Audio Feedback Options

The error beep volume in the phone is related to the volume of the speaker. You can set the beep volume using this procedure; however, adjusting the speaker volume also affects the beep volume.

To adjust the volume of the audio feedback:

1. Press **Settings** or .
2. Press **Audio Feedback**.
3. Set the options using the appropriate actions described below:

Option	Action
Turn audio feedback off for errors	Press Turn Off .
Adjust audio for error beeps	Press Volume + or Volume –
Test audio feedback volume level	Press Play Error Tone

4. Click **Save**.

Note: Press **Cancel** at any time to exit this application without making any changes.

Specify Text Size

To specify the text size that displays on the phone:



1. Press **Settings** or .
2. Press **Text Size**.
3. Select **Large Text** or **Small Text**.
4. Press **Save**.

Note: The default text size is "Small". In some instances, using Large Text size may result in truncated key labels. To restore proper key labeling, switch to the Small Text setting.



Adjust Ringer Volume and Pitch

To adjust Ringer Volume while the phone is idle:

5330 Phone:



1. Press the key that you have programmed as **Superkey**.
2. Press the **No** softkey until "Ringer Adjust?" appears.
3. Press **Ring Adjust**
4. Press **No**.
5. Press "Ringer Vol".
6. Press  (UP) or  (DOWN) .
7. Press **Save** to save ringer pitch level.
8. Press **Superkey**.

5340 Phone:



1. Press the key that you have programmed as **Superkey**.
2. Press **More** until the **Ring Adjust** option appears.
3. Press Ringer Vol.
4. Press  (UP) or  (DOWN) .
5. Press **Superkey**

To adjust Ringer Pitch while the phone is idle:

5330 Phone:

1. Press the key that you have programmed as **Superkey**.
2. Press the **No** softkey until "Ringer Adjust?" appears
3. Press **Ring Adjust**.
4. Press **Ringer Pitch**.
5. Press  (UP) or  (DOWN).
6. Press **Superkey**.

5340 Phone:

1. Press the key that you have programmed as **Superkey**.
2. Press **More** until the **Rng Adjust** option appears
3. Press Ringer Pitch.
4. Press  (UP) or  (DOWN) .
5. Press Superkey

To adjust Ringer Volume while the phone is ringing:

- Press  (UP) or  (DOWN).

Note:

- If the phone is in talk state, pressing **UP** or **DOWN** adjusts the volume of the handset, headset or speaker.
- If the phone is idle, pressing **UP** or **DOWN** adjusts the contrast.

Enable a Screen Saver

You can program your screen saver to turn on when a specific time period of inactivity has occurred on your phone. The screen saver displays set type, software load, hardware revision, and ICP software load.

To enable a screen saver:

1. Press **Settings** or .
2. Press **Screen Saver**.
3. Select the inactivity time that will activate the backlight switch to dim.
4. Press the checkbox beside **Display image** if you want the screen saver image to display. If you prefer to have backlight dimming only (no image), then do not select this box.
5. You can use the **Brightness** options to adjust the brightness of the screen saver if necessary.
6. Press **Save**.

Programming Features On Your Keys

You can assign Features (like "Speed Call") or Applications (like "People") to the programmable keys on your phone.

Most features can be programmed using the Settings key  but the following features/settings require you to use a Superkey (which you have programmed to a key):

- Advisory Message
- Call Logging/History
- Display Key Programming (5340 only)
- Speed Call when "Private" setting is required
- Split Call Forwarding
- Ringer Adjustments
- Language setting
- Display Name changes
- Night Answer

Note: Features available on the Superkey are dependent upon system programming. See your System Administrator if you require a feature that is not listed on your phone.

Features available for programming on programmable keys:

Features listed with an asterisk are listed under the Settings key but are not functional in this release. Use the Superkey to program these features.

Feature	Default Label
Account Code Verified	Acct Verified
Alarm	Alarm
Auto Answer	Auto Ans
Call Block	Call Block
Call Park	Call Park
Call Pickup	Call Pickup
Callback	Call Back
Call History*	Call Hist
Campon	Campon
Day/Night	Day/Night
Direct Page	Page
Do Not Disturb	DND
Double Flash	Dbl Flash
Forward all*	Fwd all
Forward Always*	Fwd Always
Forward Busy*	Fwd Busy
Forward Busy/No Answer*	Fwd B/NA
Forward Call*	Fwd call
Forward No Answer*	Fwd No Ans

Feature	Default Label
Group Listen	Grp Listen
Guest Room	Guest Room
Handset Mute	Hndset Mut
Headset	Headset
Music	Music
Night Answer	Night Ans
Open Door	Open Door
Orbit	Orbit
Override	Override
Paging*	Paging
Park PA	Prk PA
Park Page	Prk Page
Park Page Group	Prk Pg Grp
Park Page Set	Prk Pg Set
Phonebook	Phonebook
Privacy Release	Privacy Rls
Record Call	Rec Call
Release	Release
Respond	Respond
Single Flash	Flash
Speed Call	Speed Call
Superkey	Superkey
Swap	Swap
System Park	System Prk
Voice Mail	Voice Mail
Voice Mail Prompts	VM Prompts
Wake Up Alarm	WkUp Alarm

Note: Some feature availability is dependent upon system programming.

For more information about programming Features and Fixed Functions to a key see [Program Feature Keys Using the Setting Application](#) on page 15.

For more information about programming Applications to a key, see [Programming Applications on Your Keys](#) on page 17.

Note: Only the System Administrator can program "line select" and "line appearance" keys. By default, the user's Prime line is Key 1.

Program Feature Keys Using the Settings Application

To program a phone feature:

1. Press **Settings** or .
2. Press **Programmable Keys**.
3. Press the key you want to program.
4. If Applications are displayed, press the **View Features** softkey. (Conversely, if you want to program an application to this key, and features are displayed, press the **View Applications** softkey.)
5. Use the Page Navigation keys to move through the features list. (Features are listed in the order they are most frequently used.)
6. Select the desired feature or fixed function key from the list. A default label is automatically assigned to the key. If you want to personalize the label, refer to *Edit Key Labels* on page 15.
7. Enter the required information in the fields provided, if necessary.
8. Press **Save**.
9. Press **Close**.

Edit Key Labels

To change the labeling of a programmed feature key:

1. Press **Settings** or .
2. Press Programmable Keys.
3. Select the key you want to edit.
4. Press **Edit Label**.
5. Press **Backspace** to remove the existing label, if required.
6. Use the [dial pad](#) or the [onscreen keyboard](#) to enter the new label.
7. When label entry is complete, press **Save**.
8. Press **Close** to exit the Settings application.

Clear Programming from a Key

You may wish to clear the programming from a key if you are no longer using it.

To clear the feature or application programming from a key:

1. Press **Settings** or .
2. Press **Programmable Keys**.
3. Press the key you wish to clear.
4. Press **Clear Key**.
5. Either press **Close** or reprogram the key.

Program Superkey to a Key

To program a feature key to be the Superkey:

1. Press **Settings** or .
2. Press **Programmable Keys**.
3. Press the key you wish to program.
4. If Applications are displayed, press **View Features**.
5. Use the Page Navigation keys to move through the features list.
6. Select **Superkey**.
7. Press **Save**.

Note: You cannot program a Superkey on keys 31 to 48 of the 5340 phone.

Program Feature Keys Using the Superkey

To program a phone feature key:

5330 Phone:

1. Press the key that you have programmed as **Superkey**.
2. Press **No** until Personal Keys? appears and then press **Yes**.
3. Press the key you want to program.
4. Press **Change**.
5. Press **No** until the key type you want to program appears, and then press **Yes**.
6. Press **Save**.

5340 Phone:

1. Press the key that you have programmed as **Superkey**.
2. Press the **More** key until the **Feature Key** option appears, if necessary.
3. Press **Feature Key**.
4. Press the key you want to program.
5. Press **Change**.
6. Select the key type to program. (Press **More** to scroll, if necessary.)
7. Press **Save**.

To program Speed Call

You can use the Settings key or the Superkey to program Speed Calls keys.

Note: The Settings key does not offer the "Private" option. If you want the Speed Call number to be private, use the Superkey to program it.

To program Speed Call Using the Settings Key:

1. Press **Settings**.
2. Press **Programmable Keys**.
3. Select the key to program.
4. Use page navigation keys to find Speed Call
5. Press **Edit Label** to enter label info using the [dial pad](#) or the [onscreen keyboard](#).
6. Press **Edit Number** to enter number using the dial pad and then press **Save**.
 - Maximum length is 26 characters (valid characters are 0-9, # and *.)
7. Press **Save**.

To Program Speed Call Using Superkey:**5330 Phone:**

1. Press the key that you have programmed as **Superkey**.
2. Press **No** until Personal Keys? appears and then press **Yes**.
3. Press the key you want to program.
4. Press **Change**.
5. At the Speed Call? prompt, press **Yes**.
6. Enter the speed call number using the dial pad.
7. If you want the number to be private, press **Priv**.
8. Press **Save**. Key programming is saved with the default "Speed Call" label.
9. Press **Superkey** to exit. To edit the label or number, refer to *Editing Key Labels* on page 15.

5340 Phone:

1. Press the key that you have programmed as **Superkey**.
2. Press the **More** key until **Feature Key** appears.
3. Press **Feature Key**.
4. Press the key you want to program.
5. Press **Change**.
6. Press **Speed Call**.
7. Enter the speed call number using the dial pad.
8. If you want the number to be private, press **Priv**.
9. Press **Save**. Key programming is saved with the default "Speed Call" label.
10. Press **Superkey** to exit. To edit the label or number, refer to *Editing Key Labels* on page 15.

Programming Applications on Your Keys

The following applications are available for programming on programmable keys:

- Applications List
- People
- Conference Unit
- Settings
- Help
- Cordless Devices

To program a Phone Application:

1. Press **Settings** or .
2. Press **Programmable Keys**.
3. Press the key you want to program.
4. If Features are displayed, press **View Applications**.
5. Select the desired application.
6. Press **Save**.
7. Press **Close**.

Note: The Applications List feature key may display an incorrect count of available applications.

Making And Answering Calls

You can make a call using one of the following methods:

- Press the programmed Speed Call key associated with the party you want to call. For more information about programming keys, see [Programming Features On Your Keys](#) on page 13.
- Dial the number using the dial pad.
- Use the **People** application.
- Use the **Phone Book** feature (on page 19.)

Using the People Application

You can use the People Application to maintain a list of contacts with one-touch dialing.

To add a name to your contact list using the People application:

1. Open the *People* application.
2. Press **New**.
3. Enter the number using the [dial pad](#) or the [onscreen keyboard](#). (Valid characters are 0-9, #, and *.)
4. Press **Save**. The Name window appears.
5. Enter the name of your contact using the [dial pad](#) or the [onscreen keyboard](#).
6. Press **Save**.
7. Press **Close**.

To edit information in your People list

1. Open the *People* application.
2. Press the name you want to edit. (If you want to delete the name from your contact list, press **Delete**.)
3. Press **Edit Name**.
4. Using the [dial pad](#) or the [onscreen keyboard](#), update the appropriate information.
5. Press **Save**.
6. Press **Edit Number**.
7. Using the [dial pad](#) or the [onscreen keyboard](#), update the appropriate information. (Valid characters are 0-9, #, and *.)
8. Press **Save** followed by **Close**.

To dial a contact from your People list:

1. Open the People application.
2. Use the navigation keys to page through the contact list and select the name.
3. Dial the contact name using one of the following methods:
 - Select a contact name and press Dial.
 - Press the key to the right of the contact's dial icon in the main list. (The contact name does not need to be selected.)
4. Continue the call using the speakerphone or lift the handset.

Phone Book

To use Phone Book:

1. Press **Phone Book** (if available) or the key programmed as **Phone Book**.
2. Enter the name of the desired party, as follows:
 - For each letter in the name, press the appropriate key on the keypad until the letter is shown in the display. For example, if the letter C is required, press the '2' keypad digit three times.
 - Use the <— softkey to correct errors.
 - If required, press —> softkey to add a space between the first and last name.
3. Press the **Lookup** softkey.
4. If no match exists, edit the original entry.
5. If more than one match is found, press the **Next** softkey.
6. Do one of the following:
 - To make the call, press the **Call** softkey.
 - To edit the entry, press the **Backup** softkey.
 - To exit, press **Close** or **Superkey**.



Answer a call

Do one of the following:

- Select the programmable line key for the ringing line that is flashing.
- Lift the handset or press  (**SPEAKER**).

End a call

Do one of the following:

- Press **Hang Up** or **Cancel** (.
- Replace the handset.
- Press the key that you have programmed as Cancel.
- If you are in Handsfree mode, press  (**SPEAKER**).

Redial

To redial the last number that you manually dialed:

1. Lift the handset (optional).
2. Press  (**REDIAL**) or the key you programmed as **Redial**.

Handsfree Operation

To use Handsfree to make a call:

1. If you want to use a Non-Prime Line, press a Line Appearance key.

Note: Your administrator must program Line Appearances to your phone.

2. Dial the number.
3. Begin speaking when the called party answers. Your phone's Handsfree microphone and Handsfree speaker transmit and receive audio.

To use Handsfree operation to answer calls:

- Press the flashing line key.
- Begin speaking. Your phone's Handsfree microphone and Handsfree speaker transmit and receive audio.

To hang up while using Handsfree operation:

- Press  (**SPEAKER**).

To turn Mute on during Handsfree operation:

- Press  (**MUTE**). The Mute key light turns ON.

To turn Mute off and return to conversation:

- Press  (**MUTE**). The Mute key light turns OFF.

To disable Handsfree operation:

- Lift the handset.

To return to Handsfree operation:

1. Press  (**SPEAKER**).
2. Hang up the handset.

Auto Answer

When the Auto Answer feature is active, incoming calls ring briefly, and then the phone answers the call in Handsfree mode. You can continue the call handsfree or use the handset.

To enable or disable Auto-Answer:

- Press the key you have programmed as **Auto Answer**. The key is illuminated and all incoming calls are answered in Handsfree mode.

To switch from Handsfree mode to handset mode:

- Lift the handset.

To end a call, do one of the following:

- Press  (**Cancel**)
- Press the **Hang Up** softkey.
- Wait for the caller to hang up.

Call Handling

Hold

To place a call on Hold, do one of the following:

- Press  (**HOLD**).
- Press the key that you have programmed as **Hold**. The indicator flashes on the line that has the held call.

Note: You can only retrieve a call from hold when the phone is idle.

To retrieve a call from Hold, do one of the following:

- Lift the handset and press the flashing line.
- Press the flashing indicator.

To retrieve a call from Hold at another phone, do one of the following:

- Press the flashing line key.
- Dial the appropriate feature access code and the number of the station that placed the call on Hold.

Mute

Mute lets you temporarily turn your phone's handset, headset or handsfree microphone off during a call.

To turn Mute on during a call:

- Press  (**MUTE**). The  (**MUTE**) light turns ON.



To turn Mute off and return to the conversation:

- Press  (**MUTE**). The  (**MUTE**) light turns OFF.

Note: If you are on a Handsfree MUTED call and you lift the handset, the handset microphone is automatically enabled and the MUTE light turns OFF.

Transfer

To transfer an active call:



1. Press  (**TRANS/CONF**).
2. Dial the number of the third party.
3. Do one of the following:
 - To complete the Transfer, hang up.
 - To announce the Transfer, wait for an answer, consult, and hang up.
 - To cancel the Transfer, press  (**CANCEL**).

To transfer an active call during headset operation:

1. Press  (**TRANS/CONF**).
2. Dial the number of the third party.
3. To complete the Transfer, press the Release feature key.

Conference

To form a Conference when a two-party call is already in place, or to add another party to an existing Conference:

1. Press  (TRANS/CONF).
2. Dial the number of the next party.
3. Wait for an answer.
4. Press  (TRANS/CONF).

To leave a Conference:

- Hang up or press  (CANCEL).

Swap

To call another party when you are in an established two-party call:

1. Press  (TRANS/CONF).
2. Dial the number.

To alternate between the two parties:

- Press the key you have programmed as **Swap**.

Call Forwarding

Call Forwarding lets you redirect incoming calls to an alternate number when your phone is busy, when you're not answering, or all the time.

You can use the Settings key to set a global forwarding option for all calls, or to program a feature key with a desired forwarding method. If you need one forwarding setup for Internal calls and a different setup for External calls, use the Superkey to program Call Forwarding.

Programming Call Forward

To set a global Call Forward option for all calls:

5330 Phone:

1. Press the key that you have programmed as **Superkey**.
2. Press **No** until "Call Forwarding?" appears, if necessary.
3. Press **Yes** to select **External** or **Internal** calls.
4. Use the **Next** key to navigate through the Call Forward categories (Always?, If Busy?, No Ans?, etc.) and then press **Pgm** to select.
5. Enter the number to which you want your calls forwarded and then press **Save**.

5340 Phone:

1. Press the key that you have programmed as **Superkey**.
2. Press the **More** key until the Forwarding option appears.
3. Press the **Forwarding** key.
4. Press the key for your desired forwarding option (Busy, Always, To me, No Ans)

To program a feature key with a specific call forward option:

5330 Phone:

1. Press the key that you have programmed as **Superkey**.
2. Press **No** until "Personal Keys?" appears, and then press **Yes**.
3. Select the key on your phone that you want to program.
4. Press **No** until your desired forwarding option (FWD ALWAYS, BUSY, NO ANS, etc.) appears and then press **Yes**.
5. Press **Superkey**.

5340 Phone:

1. Press the key that you have programmed as **Superkey**.
2. Press the **More** key until the Feature Key option appears.
3. Press **Feature Key**.
4. Select the key on your phone that you want to program.
5. Press **Change**.
6. Press **More** until your desired forwarding option appears and then select it.

Using Other Features

Account Codes

An account code is a series of digits that you assign to your calls, usually for accounting purposes. The code identifies the account in the call records that your system generates. A forced account code is usually entered from another extension, enabling you to use features or make calls that the extension otherwise could not. If you want this feature enabled on your phone, ask your System Administrator.

To use Account Codes:

1. Lift the handset.
2. Dial the Account Code digits.
3. Press #.

To enter an Account Code during a call:

1. Press the key that you have programmed as **Account Code Verified**.
2. Dial the Account Code digits.
3. Press the **Save** softkey.

ACD

If your phone is ACD-enabled, you can log in as an agent.

To log in as an ACD agent:

1. Lift the handset.
2. Dial the ACD Login/Logout feature access code.
3. Enter your Agent ID, using the key pad.
4. Press **Enter**. The display reads LOGGED IN.

Attendant Call Hold - Remote Retrieve

To retrieve a call placed on Hold by the attendant:

1. Lift the handset.
2. Dial the "Call Hold – Remote Retrieve" feature access code.
3. Dial the digits announced by the attendant.

Auto Latch Microphone

To set the Handsfree microphone to automatically turn on or off when receiving a page or Intercom call:

1. Press the key you have programmed as **Superkey**.
2. Press **More** until **Auto Latch Mic** appears.
3. Press Auto Latch Mic.
4. Press **TurnOn** or **TurnOff**. The microphone key flashes to indicate that the Auto-Latch Microphone feature is in use.

Callback

The Callback feature allows you to be notified when a busy phone becomes free or when a phone has been used after a no-answer condition was encountered.

To request a Callback when you reach a busy or unanswered station:

1. Press **Call Me Back**.
2. Hang up.

When the party is available, your phone rings and the display shows the Callback ringing indicator.

To answer a Callback:

- Lift the handset.

Call Forward - Remote (I Am Here)

You can program "I Am Here" forwarding from a remote station or from your current location.

To forward calls from a remote station to your current location:

5330 Phone:

1. Press the key that you have programmed as **Superkey**.
2. Press the **No** softkey until "Call Forwarding?" appears.
3. Press the **Yes** softkey.
4. Press the **Next** softkey until "I Am Here" appears.
5. Press the **Yes** softkey.
6. Enter the extension of the remote station. If you make an error while dialing, use the <— softkey to backspace and correct the number.
7. Press  (**DOWN**) or the **Save** softkey.

5340 Phone:

1. Press the key that you have programmed as **Superkey**.
2. Press the **More** key until "Forwarding" appears.
3. Press **To Me**.
4. Enter the extension of the remote station. If you make an error while dialing, use the <— softkey to backspace and correct the number.
5. Press **Save/On**.

To cancel "Call Forward – Remote" from the station that was forwarded (the remote station):

5330 Phone:

1. Press the key that you have programmed as **Superkey**.
2. Press **No** until "Call Forwarding?" appears and then press **Yes**. Programmed settings appear with an * beside the name.
3. Press **Yes** to change the programmed setting.
4. Press **Chg**.
5. Press **TurnOff**.

5340 Phone:

1. Press the **Forwarding** softkey.
2. Press **Prev** or **Next** to navigate to the setting you want to change.
3. Press **FWD/OFF**.

To cancel "Call Forward – Remote" from the station that received the forwarded calls (the current location):

1. Lift the handset.
2. Dial the "Call Forwarding – Cancel I'm Here" feature access code.
3. Hang up.

Call Logging (Call History)

Call Logging keeps track of the names (if available) and telephone numbers of all your incoming calls or only those you missed.

To program your phone to log incoming calls:

5330 Phone:

1. Press the key that you have programmed as **Superkey**.
2. Press **No** until "Call Logging?" appears and then press **Yes**.
3. Select **Missed** calls or **All** calls.
4. Press **Internal** to log calls from other extensions only, **External** to log outside calls only, or **Both** to log both internal and external.

5340 Phone:

1. Press the key that you have programmed as **Superkey**
2. Press the **More** key until "Call Logging" appears
3. Press **Call Logging**.
4. Select **Missed** calls or **All** calls.
5. Press **Internal** to log calls from other extensions only, **External** to log outside calls only, or **Both** to log both internal and external.

To turn off call logging:

5330 Phone:

1. Press the key that you have programmed as **Superkey**.
2. Press **No** until "Call Logging?" appears and then press **Yes**.
3. Select **Off**.

5340 Phone:

1. Press the key that you have programmed as **Superkey**
2. Press the **More** key until "Call Logging" appears
3. Press **Call Logging**.
4. Select **Off**.

To display the call log:

5330 Phone:

1. Using the **Settings** key, program a **Call History** feature key. (see page 16 for key programming instructions.) The Call History feature key illuminates when call history is present.
2. Press **Call History** to display the number of old calls and new calls. Press **New Calls** to view calls that have arrived since your last review or press **Old Calls** to view previously-viewed calls
3. Press **Delete** to delete the current call. Press **Delete All** to delete all call logs. Press **Call** to return the call.

5340 Phone:

1. Press the **Callers** softkey to display the number of old calls and new calls. (Note: this key is only available when call history data is present.)
2. Press **New Calls** to view calls that have arrived since your last review or press **Old Calls** to view previously-viewed calls.
3. Press **Delete** to delete the current call. Press **Delete All** to delete all call logs. Press **Call** to return the call.

Call Park

The Call Park feature allows you to place a call in a special hold state. You, or someone else, can then retrieve the call from any extension in the system.

After parking the call, the system can automatically connect you to paging equipment so that you can announce the call to the requested party.

To park an active call:

1. Do one of the following:
 - Press the key that you have programmed as **Call Park**.
 - Press  (TRANS/CONF), and then dial the appropriate feature access code. The display shows PARKED@, followed by the park destination and parking spot index (if applicable). Example: PARKED@ 1234 @ 02.
2. Dial the directory number on which to park the call (not required if the number is programmed to the **Call Park** feature key).
3. To inform a user that a parked call is waiting, do one of the following:
 - If automatic paging is enabled, announce the call and the park retrieve digits shown on the display.
 - If automatic paging is disabled, press the programmed **Page** key, or dial the appropriate feature access code, followed by the Paging zone number (if required). Then, announce the call and park retrieve digits shown on the display.

Note: Paging over a loudspeaker is not permitted in handsfree mode; you must use the handset or headset.

To retrieve a parked call:

1. Dial the "Call Park Orbit Retrieve" feature access code.
2. Dial the two-digit orbit number.

Call Pickup

To answer a call that is ringing at another extension in your Pickup Group:

1. Lift the handset.
2. Press the key that you have programmed as **Call Pickup**.

To answer a call that is ringing at another extension not in your Pickup Group:

1. Lift the handset.
2. Dial the Directed Call Pickup feature access code.
3. Dial the number of the ringing station.

Campon

When you get a busy tone, you can use the Campon feature to be notified when the busy party becomes available.

To Campon to a busy station:

- Press the **Wait** softkey (5330) or the **I'll Wait** softkey (5340)

To retrieve a call when you hear the Campon tone:

- You can use the Call Swap feature with the  (TRANS/CONF) hardkey or a programmable line key.

Direct Paging

Direct Paging allows you to page a party through the party's handsfree speaker. If the paged party has Off-Hook Voice Announce enabled, the page will be heard even when the party is on a handset or headset call. If the paged party has Handsfree Answerback enabled and turned on at the phone, your page automatically establishes a handsfree call with the paged party.

To page a party:

1. Lift the handset.
2. Press the Direct Paging feature key you have programmed, or dial the appropriate feature access code.
3. Dial the extension number.
4. Speak to the dialed party after the tone.

How you answer a Direct Page depends on whether Handsfree Answerback is enabled and turned on at your phone. See one of the following procedures:

- Direct Paging - Handsfree Answerback Enabled
- Direct Paging - Handsfree Answerback Disabled

Direct Paging - Handsfree Answerback Enabled

When you receive a Direct Page, Handsfree Answerback automatically establishes a Handsfree call on your phone after a single burst of tone.

Your administrator enables or disables Handsfree Answerback on your phone. After your administrator enables Handsfree Answerback, you can choose to turn it on or off directly from your phone.

To turn Handsfree Answerback on:

- When your phone is idle, press  (**MUTE**) once. The MUTE key light flashes to indicate that Handsfree Answerback is ON.

- When a Direct Page arrives, the MUTE key light turns OFF and a Handsfree call is automatically established.

To turn Handsfree Answerback off:

- Press the flashing  (**MUTE**) key once. The MUTE key light turns OFF.
- To respond to a Direct Page when Handsfree Answerback is OFF, see "Direct Page - Handsfree Answerback Disabled" elsewhere in this guide.

Note: By default, Handsfree Answerback is turned OFF at your phone. If the  (**MUTE**) key is OFF when your set is idle, Handsfree Answerback is OFF.

To answer a call using Handsfree Answerback:

Phone state before Page arrives

Phone is idle and MUTE is flashing

To answer the Direct Page

1. Check that MUTE is OFF.
2. Listen for the paging party.
3. Begin speaking.
4. Lift the handset if you wish to switch from a Handsfree call to a handset call.

You are on a handset or headset call, and MUTE is OFF

1. Check that MUTE is flashing.
2. Press MUTE. The light turns ON solid, and you are now speaking to the paging party and have muted your handset/headset call.
3. Speak to the paging party. Press MUTE to alternate between handset/headset and handsfree calls.

You are on a MUTED handset/headset call, OR, you are on a Handsfree call

The party paging you receives a busy tone. Handsfree Answerback does not interrupt your call.

To end a Handsfree Answerback call:

- Press either  (**SPEAKER**) or  (**CANCEL**).

When the Handsfree Direct Page call ends, the MUTE key light returns to the state it was in before the call was established.



Direct Paging - Handsfree Answerback Disabled

Your administrator enables or disables Handsfree Answerback and you can also turn it on or off on your phone. To turn Handsfree Answerback off, see "Direct Paging - Handsfree Answerback Enabled" elsewhere in this guide. When Handsfree Answerback is disabled on your phone and you receive a Direct Page, the Direct Page is indicated by a single burst of tone.

To answer Direct Page calls when Handsfree Answerback is disabled:

Phone state before Page arrives:	To answer the Direct Page (indicated by single burst of tone):
Phone is idle and MUTE is OFF.	<ol style="list-style-type: none"> 1. Check that MUTE is ON solid. 2. Lift the handset OR press MUTE key to answer in Handsfree mode. (The light turns OFF.) 3. Begin speaking.
You are on a handset call or headset call, and MUTE is OFF	<ol style="list-style-type: none"> 1. Check that MUTE is flashing. 2. Press MUTE. The light turns ON solid and you are now speaking to the paging party and have MUTED your handset/headset call. 3. Speak to the paging party. Press MUTE to alternate between handset and handsfree calls.
You are on a MUTED handset/headset call, OR, you are on a Handsfree call	The party paging you receives a busy tone. Handsfree Answerback does not interrupt your call.

To end a Direct Page call, do one of the following:

- Hang up the handset to end a handset call.
- Press  (**SPEAKER**) to end a Handsfree call.
- Press  (**CANCEL**).

When the Handsfree Direct Page call ends, the (MUTE) key light returns to the state it was in before the call was established.

Do Not Disturb

When you enable Do Not Disturb, callers are immediately transferred to voice mail.

To activate or deactivate Do Not Disturb:

- Press the **Do Not Disturb** key that you programmed. The key is illuminated when Do Not Disturb is activated and is not illuminated when Do Not Disturb is not activated.

Group Listen

With Group Listen, you can carry on a conversation using the handset or headset while allowing others nearby to listen to the person at the far end over the handsfree speaker. The handsfree microphone is disabled in Group Listen mode.

To activate Group Listen while in a handset conversation:

- Press the key you have programmed as **Group Listen**. Audio from the far-end party is now heard through both the handset/headset and the speaker.

To make the call a normal two-way speaker call:

- Press  (**SPEAKER**).

To exit Group Listen mode (and return to a normal handset/headset call):

- Press the **Group Listen** key.

To activate or deactivate Group Listen while in headset mode:

- Press the **Group Listen** key.

Group Paging / Meet Me Answer

Group Paging allows you to page a group of telephones through their built-in speakers. You can belong to as many as three paging groups with one group designated as your "prime" group.

When you need to respond to a Group Page but don't know the identity or extension number of the paging party, use the Meet Me Answer feature. You have up to 15 minutes after receiving the page to use Meet Me Answer.

To make a Group Page:

1. Lift the handset.
2. Press the **Direct Page** key you programmed, or dial the Direct Paging feature access code.
3. Do one of the following:
 - To page your prime page group, press #.
 - To page a specific page group, dial the page group directory number.
4. Speak to the dialed party after the tone.

To respond to a Group Page by using Meet Me Answer:

1. Lift handset.
2. Dial the "Meet Me Answer" feature access code.
3. Do one of the following:
 - To respond to a page from your prime page group, press #.
 - To respond to a page from a specific page group, dial the page group directory number.

Headset Operation

To enable Headset Operation:

- Press the key that you have programmed as **Headset Mode**.

To answer a call (when Auto Answer is disabled):

- Press the flashing line key.

To answer call (when Call Notification is enabled)

- Select **Close** and then select the prime line.

To hang up:

- Press  (**CANCEL**).

To mute your headset microphone:

- Press the  (**MUTE**) key. The light turns ON.

To turn mute off and return to the conversation:

- Press the  (**MUTE**) key. The light turns OFF.

Make Busy

When the ACD feature is enabled, you can use the Make Busy feature to have your phone appear busy to other callers. If callers dial your phone number when Make Busy is enabled, a message indicating that your line is busy is displayed on their phones.

To enable Make Busy:

- Press the key that you have programmed as **Make Busy**. The key illuminates when Make Busy is activated and *MAKE BUSY* is displayed.

To disable Make Busy:

- Press the key that you have programmed as **Make Busy**. The key light goes out.

Messaging - Advisory

Advisory Messaging enables you to select a notice that appears on your phone display to inform people calling you of your whereabouts. Select from a variety of advisory messages, including "On vacation", "In a meeting", or "Out to Lunch".

To turn Messaging - Advisory on:

5330 Phone:

1. Press the key that you have programmed as Superkey.
2. Press the **No** softkey until "Advisory" appears and then press **Yes**.
3. Press the Next softkey until the desired message appears.
4. Press the **TurnOn** softkey.

5340 Phone:

1. Press the **Messaging** softkey.
2. Press the **Advisory** softkey.
3. Press **Next Msg** until the desired message appears.
4. Press **Turn Msg On**.

To turn Messaging - Advisory off:

5330 Phone:

1. Press the key that you have programmed as Superkey.
2. Press the **No** softkey until "Advisory" appears and then press **Yes**.
3. Press the **TurnOff** softkey.

5340 Phone:

1. Press the **Messaging** softkey.
2. Press the **Advisory** softkey. The set displays the current advisory message.
3. Press **Turn Msg Of**.

Note: You can also create your own Advisory Messages if your System Administrator has programmed this option. When a custom advisory message is enabled and in use on more than one 5340 phone, hitting the Create Message softkey supplies a "Force Off" softkey. This key allows you to force the message to change on all phones where that message is in use.

Messaging - Callback

To leave a Callback Message when you hear busy or ringback tone:

- Press  (**MESSAGE**) or press the key you have programmed as **Callback**.

To respond to a message waiting condition on your phone:

- To immediately call the extension that left the message, press  (**MESSAGE**).

To display information about the message:

5330 Phone:

1. Press the key that you have programmed as **Messaging**. The calling number and time of call are displayed.
2. Press the Message key for subsequent messages.

OR

- Press the **Messaging** softkey for Call and Erase options only.

5340 Phone:

1. Press the key that you have programmed as **Superkey**.
2. Press the **More** key until "Messaging" appears.
3. Press **Read Msg**. The calling number, time, and date of the call are displayed.
4. Press **Call** or **Erase**.
5. Press **Next** and **Previous** to navigate through multiple messages.

Messaging - Cancel Callback

To cancel a Callback:

5330 Phone:

1. Lift the handset
2. Dial the appropriate feature access code.
3. Dial the number of the called station.
4. Hang up.

5340 Phone:

1. Press the key that you have programmed as **Superkey**.
2. Press the **More** key until "Messaging" appears.
3. Press **Msgs/Sent**
4. Press **Erase Msg**
5. Press **Superkey**.

Music

To turn Music on and off when the phone is idle, do one of the following:

- To toggle music on and off, press the key that you have programmed as **Music** or the Music softkey.

When the Music feature is activated, the programmed **Music** key is illuminated.

Night Answer

The Night Answer feature allows you to route calls to an attendant or message at night.

To enable/disable Night Answer:

5330 Phone:

1. Using Superkey, program a Night Answer feature key (See page 16 for instructions to program keys using the Superkey.)
2. Press the key that you have programmed as **Night Answer**. When enabled, the key is illuminated.
3. Press the **Night Answer** key again to disable.

5340 Phone:

1. Program a Night Answer feature key using the Settings key or Superkey. (See page 15 for instructions to program keys using the Settings key.)
2. Press the key that you have programmed as **Night Answer**. When enabled, the key is illuminated.
3. Press the **Night Answer** key again to disable.

Override (Intrude)

When you dial a number whose owner has enabled Make Busy, your phone displays a message indicating that the line is busy. You have the option to override this setting.

To use Override when you encounter a busy tone:

1. Press the key you programmed as **Override**.
2. Wait for an answer.

Paging

To use Paging:

1. Lift handset.
2. Press the **Page** softkey or the key that you have programmed as **Page**.
3. Dial the Paging zone number (if required).
4. Make the announcement.

Record a Call

This feature uses your voice mail system to record your telephone conversations.

Note: You may be required by law to inform the other party that you are recording the conversation. For specific instructions, consult your system administrator.

To start recording while on a 2-party call:

- Press the key you have programmed as **Record Call**.

Note: Your system may be programmed to automatically begin recording external calls when you or the other answers.

To control recording, do one or all of the following:

- To pause recording, press the **Pause** softkey.
- To resume recording after pausing, press the **Resume** softkey.
- To stop a recording without saving it, press the **Erase** softkey or  (**CANCEL**).
- To stop and save a recording, press the **Save** softkey.

Putting the call on hold saves the recording; taking the call off hold starts a new recording. Depending on system programming, hanging up or pressing  (**TRANS/CONF**) or a **DSS** key, may also save the recording.

To listen to a recording:

1. Lift the handset.
2. Access your voice mailbox.
3. Follow the prompts to retrieve the recording.

Reminder

Note: The Reminder feature will not work if Auto Answer is enabled on your phone.

5330 Phone:

1. Press the key that you have programmed as Superkey.
2. Press the **No** softkey until "Timed Reminder" appears and then press **Yes**.
3. Enter the time and press the **AM** or **PM** softkey.

5340 Phone:

1. Press the key that you have programmed as Superkey.
2. Press **More** until **Reminder** appears.
3. Press **Reminder**
4. Enter the time and press the **AM** or **PM** softkey.

To view/change and/or cancel a pending Reminder:

5330 Phone:

1. Press the key that you have programmed as Superkey.
2. Press the **No** softkey until "Timed Reminder?" appears and then press **Yes**.
3. Do one of the following:
 - To change the Reminder, enter the new time and press **Save**.
 - To cancel the Reminder, press **Cancel**.
 - To exit without changing the Reminder, press **Superkey**

5340 Phone:

1. Press the key that you have programmed as Superkey.
2. Press **More** until **Reminder** appears.
3. Do one of the following:
 - To change the Reminder, enter the new time and press **Save**.
 - To cancel the Reminder, press **Cancel**.
 - To exit without changing the Reminder, press **Superkey**

To acknowledge a Reminder when your phone rings once:

Press the Acknowledge softkey.

Speed Call

Speed Call is an application that allows you to dial a specific number with one key press. You must program Speed Call on a programmable key. For information about programming this key, see *Programming Speed Call* on page 16.

To make a Speed Call:

- Press the key that you have programmed as **Speed Call**.

Trunk Flash

The Trunk Flash feature allows you to access Centrex features (if available) while you are talking on an outside call.

To flash a trunk while talking on an outside call:

1. Press the key you have programmed as **Flash**.
Note: You can program a key to single flash or double flash.
2. Wait for dial tone.
3. Dial the Centrex feature access code.

Using Your Phone With The 5310 IP Conference Unit

Your phone uses the 5310 IP Conference Unit for conferencing. You use the Conference Controller to turn the conference unit off or on, to adjust the volume or to put the conference unit into Presentation mode. You can only run one Conference Controller session at a time. If the 5310 Conference Unit is not connected to your phone, the *Conference Controller* application is not available.

Access the Conference Controller

To access the Conference Controller:

1. Press **Applications** and press **Conference Unit**, or
2. Press the key you have programmed to the *Conference Unit* application.

Turn the conference unit on and off

1. Verify that the conference unit is connected to your phone.
2. Access the Conference Controller.
3. Press **Turn On/Turn Off**. While the Conference Unit is on, the  icon shows in the phone status line.

Adjust the conference unit volume

- Press Volume Up or Volume Down.

Place the conference unit in Presentation mode

Presentation Mode is used when only one individual is speaking to a group. If another member in the group wishes to speak, you must disable Presentation Mode. Presentation Mode minimizes extraneous noise.

To place the conference unit in Presentation mode:

- Press **Presentation Mode**.

Exit the conference controller

To exit the conference controller:

- Press **Close**.

Mute the conference unit

To mute the conference unit so that conversation in the meeting room cannot be heard by individuals being conferenced:

- Press **Mute**.

Using your Phone with Cordless Module & Accessories

The cordless handset and cordless headset provide users with the capability to move around within their own office or adjacent offices while using the telephone.

Both cordless devices connect to your IP telephone through the cordless module, which attaches to the back of the phone. The cordless headset rests and recharges in a headset cradle that attaches to the side of the telephone. The cordless handset recharges in the handset cradle.

The Cordless Devices Application (see page 45) provides access to the configuration settings and information screens that apply to the cordless module and accessories.

Note: Since only one module type can be attached to the phone at any given time, you can not use a Programmable Key Module (PKM) when the Cordless Module is attached.

CAUTION: Attempting to remove the back plate on the telephone to install the Cordless Module before disconnecting the telephone's power supply may damage the telephone. For information about installing the Cordless Module, see the *Cordless Module and Accessories Installation Guide for Mitel 5330/5340 IP Phones* available at Mitel OnLine.



Figure 1. Cordless Module and Accessories on 5300 Series Phone



Figure 2. Rear view

Elements of Your Cordless Module and Accessories

Feature (See Figure 1)

1) Cordless Module

Function

Attached to the back of the phone, the module contains a Light Emitting Diode (LED) indicating that a cordless device is in use; also indicates the state of pairing between the module and a cordless device.

2) Cordless Headset

Cordless hands free operation for calls. If you are using the cordless headset, you do not need to use the handset.

3) Cordless Headset Charging Cradle

Provides power to recharge the cordless headset battery.

4) Cordless Handset Charging Cover

Provides power to recharge the cordless handset battery. Replaces the cover supplied with the phone for corded handsets.

5) Cordless Handset

Cordless operation for handset calls. (You can transfer from the phone handset to the cordless headset at any time.)

Feature (See Figure 2)

6) Cordless Module pairing button

Function

Initiates pairing between the Cordless Module and a cordless accessory.

7) Cordless Headset Cradle cable

Connects to the Cordless Module to provide power to the charging cradle.

Handset/Headset Combinations

The following combinations of corded and cordless headset and handset are supported on the 5330/5340 IP Phone:

- Corded handset only
- Corded headset only
- Corded handset and corded headset
- Cordless handset only
- Cordless headset only
- Cordless handset and cordless headset
- Corded handset and cordless headset
- Corded headset and cordless handset

Pairing the Cordless Module and Accessories

The cordless headset and handset are optional accessories, ordered separately. Before use, each must establish communication with the Cordless Module using a procedure called pairing.

Notes:

- An IP telephone can have only one cordless handset and one cordless headset.
- A cordless handset or headset can be paired with only one IP telephone at a time.
- Pairing a new cordless handset or headset with the IP telephone overwrites the configuration of any previous handset or headset.
- Pairing cannot be performed when the cordless device is already in use.

Pairing a Cordless Accessory with the Cordless Module

To pair a cordless accessory:

1. Ensure that the battery of the cordless device to be paired is at least partially charged.
2. Press and hold down the pairing button on the back of the Cordless Module (see Figure 2 on page 37) for 5 seconds to activate telephone pairing mode. The LED on the Cordless Module blinks. The Cordless Devices application opens on the telephone and prompts you to “Press the pairing button on the cordless device now.”
3. Press and hold down the hookswitch on the cordless handset or headset for 5 seconds to activate accessory pairing mode. **Note:** on the headset, the hookswitch is the grey portion on which the logo is displayed.
4. If the device *has not* been previously paired:
 - The LED on the cordless accessory blinks. After a moment, the Cordless Devices application displays protocol, firmware, hardware, and IPEI information for the device to be paired.
 - Press **Yes** to confirm pairing. During the pairing process, a blue LED on the device flashes. The Cordless Devices application confirms the pairing by displaying the paired device name and its battery level indicator.
5. If the device *has been* previously paired:
 - Press **Yes** at the prompt, “Do you want to pair this device?”. During the pairing process, a blue LED on the device flashes. The Cordless Devices application confirms the pairing by displaying the paired device name and its battery level

indicator. At this point, you can press the key for the paired device to display the battery level, protocol, firmware, hardware, and IPEI information for the device.

- Press **Close** to exit.

To unpair a cordless accessory:

1. Press **Applications** and then press **Cordless Devices**.
2. Press the device name that you want to unpair. The information screen for the selected device appears.
3. Press **Unpair this Device**. If the accessory is in use, an error message is displays. Otherwise, the accessory is unpaired, removed from the display, and can no longer be used to interact with the phone.
4. Press **Close**.

For more information about the Cordless Devices Application, see page 46.

Cordless Module LED Indicators

The Cordless Module has a blue light-emitting diode (LED) that indicates the current status of the module (See Figure 1):

Blue LED	Function
Solid	Audio is active between the module and either the handset or headset.
Blinking	Pairing mode is active or a firmware upgrade is in progress.
Off	No audio is active.
Solid for 2 seconds	Pairing is successful.

Blinking: LED is On and Off for equal amount of time

Using the Cordless Handset

The cordless handset provides office mobility, allowing you to make and answer calls while away from your desk. Replacing the standard corded handset, the cordless handset contains a rechargeable battery that charges in the handset cradle when not in use.

To use the Cordless Handset, you must pair the handset with the phone. For more information, see Pairing the Cordless Module and Accessories on page 38.



LL0171

Figure 3. Cordless Handset on 5300 Series Phone

Elements of the Cordless Handset

Feature

1) Cordless Handset LED

2) Hookswitch Button

3) Mute button

4) Volume Up and

5) Volume Down buttons

Function

Blue: Light-emitting diode (LED) indicating the status of the handset.

Green: LED indicating the status of the handset battery.

For more information see Cordless Handset LEDs on page 42

Lifting the handset from the cradle activates the handset. If the handset is already out of the cradle, pressing the hookswitch takes the handset off-hook. Pressing the hookswitch again returns it to on-hook.

Mute allows you to turn the microphone off during a call.

Up and Down provide volume control for the ringer and handset/headset.

Note: The IP Phone deactivates the cordless handset when a corded handset is plugged in.

Answer a call

Do one of the following:

- Lift the cordless handset.
- If the handset is already out of the cradle, press the hookswitch button on the handset.

Hang up

Do one of the following:

- Replace the cordless handset in the cradle.
- Press the hookswitch button on the handset.

Dialing – Auto Dial Disabled

To dial a number with Auto Dial disabled:

1. Lift the handset or press the hookswitch.
2. Make the call using the dial pad, or press a programmed speed dial key on the phone.

Dialing – Auto Dial Enabled

To dial with Auto Dial enabled:

- To dial the predefined Auto Dial number, press the hookswitch on the cordless handset or headset.

To program Auto Dial, refer to “Using the Cordless Devices Application” on page 46.

Alerting Tones and LEDs

The cordless accessories provide the following alerting tones:

Feature	Function
Mute key on cordless device ON/OFF	2-pitch tone occurs immediately. Reminder tone occurs 30 seconds after activation and then regularly until deactivated.
Mute key on Phone ON/OFF	No immediate tone. Reminder tone occurs 30 seconds after activation and then regularly until deactivated.
Low battery (within 10 minutes left)	3 beeps and 20 second pause repeated 3 times
Low battery (within 2 minutes left)	3 rapid beeps and 1.5 second pause repeated 3 times
Out of range	Repetitive 3-pitch tone until you are back in range. The call remains established if you return within range within 10 seconds; otherwise the call is dropped.

Note: Audio indications are heard in the handset only when it is in use.

Cordless Handset LEDs

The handset has two LEDs:

- Blue – indicates the operational status of the handset
- Green – indicates the status of the electrical charge of the battery

LED Color	LED State	Indicates
Blue	Solid	Handset is muted
	Blinking	Handset is in pairing mode
	Winking	Active audio path between Handset and Module
	Off	<ul style="list-style-type: none"> • No audio path between Handset and Module OR • Battery is dead
Green	Solid	Battery is fully charged
	Blinking	Battery is charging
	Off	When handset is cradled and the LED does not flash or illuminate, this indicates an absence of battery power. During the first 30 – 60 minutes that the light is off, the battery may be trickle charging. If that is the case, the LED will resume normal behavior within that 60 minute period. If the LED remains off for more than 60 minutes, then either the battery is no longer chargeable or there is a problem in the charging circuit.

Blinking: LED is On and Off for equal amount of time

Winking: LED is On for a short period of time and Off for a longer period

Checking Battery Level of Cordless Accessories

To check the battery level, do either of the following:

- Press **Applications**, and then press **Cordless Devices**. The battery level is displayed beside the paired accessory.
- Press **Applications**, then **Cordless Devices**, and then press the key for the cordless accessory. The battery level is displayed along with protocol, firmware, hardware, and IPEI information.

Replacing Batteries in Cordless Accessories

Note: The cordless handset battery is not user-replaceable.

Viewing Cordless Accessory Information

To view cordless accessory protocol, firmware, and hardware information:

- Press **Applications**, then **Cordless Devices**, and then press the key for the cordless accessory. The battery level is displayed along with protocol, firmware, hardware, and IPEI information.

Using the Cordless Headset

The cordless headset offers the same capability as the cordless handset to make and answer telephone calls away from your desk while adding the convenience of hands-free operation.

When not in use, the cordless headset sits in the headset charging cradle.

To use the Cordless Headset, you must pair the headset with the phone. For more information, see “Pairing the Cordless Module and Accessories” on page 38.

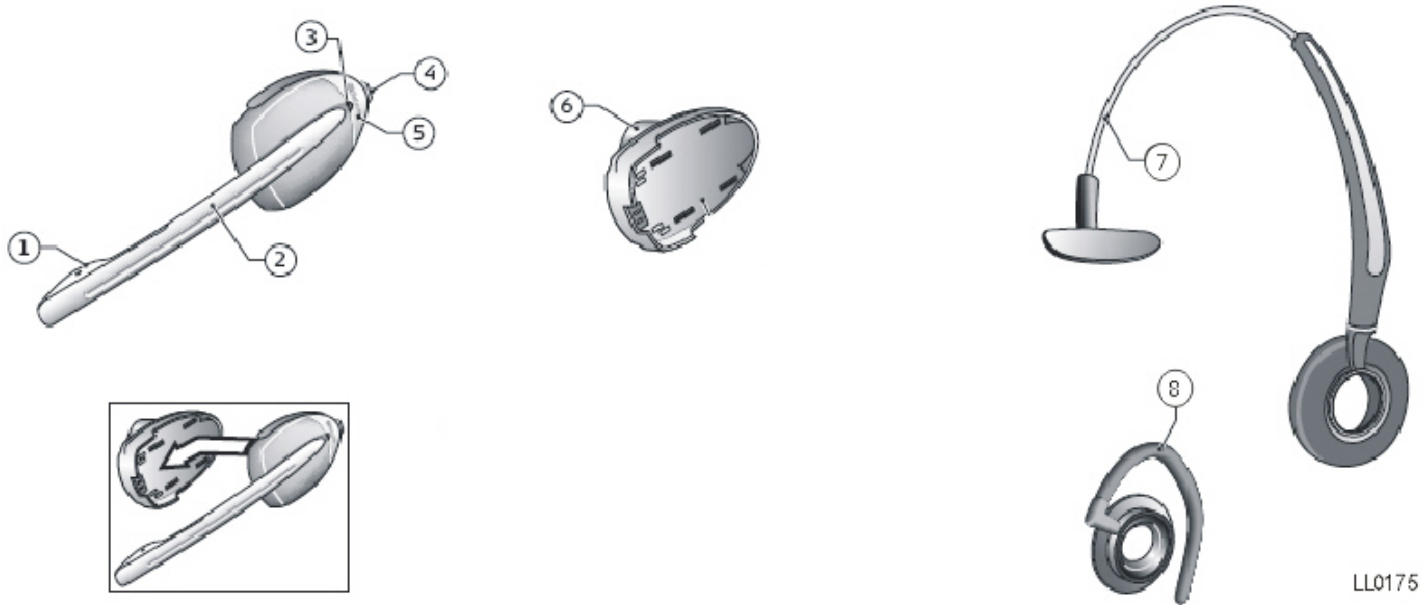

LL0175

Elements of the Cordless Headset

Feature

- 1) Microphone
- 2) Boom arm
- 3) Link indicator (LED)
- 4) Volume control with mute switch
(button on the top of the headset)
- 5) Hookswitch button (the grey portion of
the headset that displays logo)
- 6) Speaker
- 7) Headband
- 8) Ear hook

Answer a call

Do one of the following:

- Lift the cordless headset from the cradle.
- If the headset is already out of the cradle, press the hookswitch button on the headset.

Hang up

Do one of the following:

- Replace the cordless headset in the cradle.
- If the headset is already out of the cradle, press the hookswitch button on the headset.

Dialing – Auto Dial Disabled

To dial a number with Auto Dial disabled:

1. Lift the headset or press the hookswitch.
2. Make the call using the dial pad, or press a programmed speed dial key on the phone.

Dialing – Auto Dial Enabled

To dial with Auto Dial enabled:

- To dial the predefined Auto Dial number, press the hookswitch on the cordless handset or headset.

To program Auto Dial, refer to [“Using the Cordless Devices Application”](#) on page 46.

Headset Alerting Tones and LEDs

The cordless accessories provide the following alerting tones:

Feature	Function
Mute ON/OFF	2-pitch tone occurs immediately. Reminder tone occurs 30 seconds after activation and then regularly until deactivated.
Mute key on Phone ON/OFF	No immediate tone. Reminder tone occurs 30 seconds after activation and then regularly until deactivated.
Low battery (within 10 minutes left)	3 beeps and 20 second pause
Low battery (within 2 minutes left)	3 rapid beeps and 1.5 second pause
Out of range	Repetitive 3-pitch tone until you are back in range. The call remains established if you return within range within 10 seconds; otherwise the call is dropped.

Cordless Headset LEDs

There are two LEDs associated with the cordless headset:

- A blue LED on the headset indicates the headset status
- A green LED in the headset charging cradle indicates battery status

LED Color	LED State	Indicates
Blue (on headset)	Solid	Headset mic is muted
	Blinking	Headset is in pairing mode
	Winking	Active audio path between Headset and Module
	Solid for 2 seconds	<ul style="list-style-type: none"> • Pairing successful OR • New battery installed
	Off	<ul style="list-style-type: none"> • No audio path between Headset and Module OR • Battery is dead
Green (on cradle)	Solid	Battery is fully charged
	Blinking	Battery is charging
	Winking	Indicates low voltage when headset is uncradled
	Off	When headset is cradled, indicates battery is not charging.

Blinking: LED is On and Off for equal amount of time

Winking: LED is On for a short period of time and Off for a longer period

Checking Battery Level of Cordless Accessories

To check the battery level, do either of the following:

- Press **Applications**, and then press **Cordless Devices**. The battery level is displayed beside the paired accessory.
- Press **Applications**, then **Cordless Devices**, and then press the key for the cordless accessory. The battery level is displayed along with protocol, firmware, hardware, and IPEI information.

Replacing Batteries in Cordless Accessories

To replace headset battery:

1. Unclip the battery pack from the ear/head/neck piece.
2. Slide the battery pack off the headset.
3. Slide the new battery pack onto the headset. The blue headset LED indicator illuminates for two seconds to confirm successful battery replacement.
4. Re-clip the ear/head/neck piece to the battery pack.

Do not expose batteries to heat or puncture them. Dispose of the product and/or batteries according to local standards and regulations.

Note: The cordless handset battery is not user-replaceable.

Viewing Cordless Accessory Information

To view cordless accessory protocol, firmware, and hardware information:

- Press **Applications**, then **Cordless Devices**, and then press the key for the cordless accessory. The battery level is displayed along with protocol, firmware, hardware, and IPEI information.

Using the Cordless Devices Application

The Cordless Devices Application provides access to module information and pairing for hand- or headsets.

To access the Cordless Devices Application, do one of the following:

- Press **Applications** and then press **Cordless Devices**
- Press a feature key you have programmed as the Cordless Devices Application key.

For information about programming feature keys, refer to [Programming Features On Your Keys](#) on page 13.

Note: When the pairing button on the Cordless Module is pressed, or when the battery level of a cordless accessory is critically low, the phone will automatically open the Cordless Devices Application.

Viewing Cordless Module Information

You can use the Cordless Module Application to view protocol, firmware, and hardware information about the module.

To view cordless module information

1. Access the Cordless Module Application.
2. Press **Cordless Module Info**. Device information appears on the screen.
3. Press **Close** to exit.

Low Battery Level

When the battery of a cordless device reaches a near-critical level, the phone displays a warning. Until the battery is recharged (or until it becomes fully discharged), the warning is repeated at each new call made using the Prime Line. To continue with a call while charging the cordless accessory, switch to speakerphone and then cradle the cordless accessory.

Auto Dial

When a Cordless Module is installed and at least one device is paired, the Auto Dial feature is available in the Settings menu. You can program a number that is automatically dialed when a cordless device hookswitch button is pressed.

To program an Auto Dial number:

1. Press **Settings** or .
2. Press **Auto Dial**, and then press **Edit Number**.
3. Using the [dial pad](#) or the [onscreen keyboard](#), enter the auto dial number.
4. Press **Save**.
5. Press **Edit Label**.
6. Using the [dial pad](#) or the [onscreen keyboard](#), enter the label.
7. Press **Save** and then press **Close**.

To disable Auto Dial:

1. Press **Settings** or .
2. Press **Auto Dial**.
3. Press **Disable Auto Dial**. The Auto Dial settings you have programmed are maintained when the feature is disabled.
4. Press **Save**.
 - To re-enable, repeat steps 1 and 2 and then press **Enable Auto Dial**.
 - To change Auto Dial information, press **Edit Number** and/or **Edit Label**.
 - Press **Save** to save all changes.

Using a Cordless Device as a Remote Control

When not being used to talk, the cordless handset/headset buttons can act as a remote control device to change display contrast, volume, and mute settings on the host IP phone. For example, in a remote handsfree conference setting, the chairman can use the volume and mute buttons on a cordless device to adjust speaker levels and mute the microphone on an IP phone that is not within his reach. HTML applications may also make use of the cordless device buttons but functionality may differ among applications.

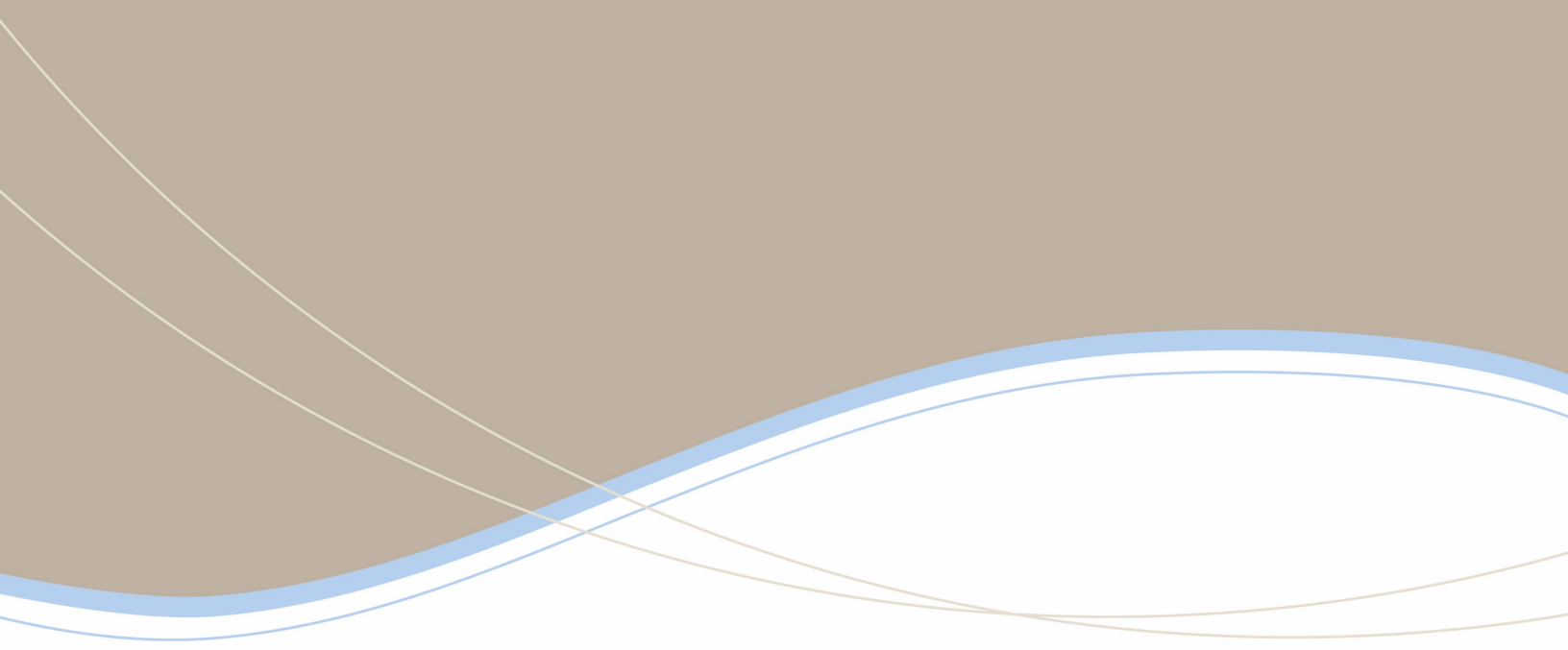

Global Headquarters	U.S.	EMEA	CALA	Asia Pacific
Tel: +1(613) 592-2122	Tel: +1(480) 961-9000	Tel: +44(0)1291-430000	Tel: +1(613) 592-2122	Tel: +852 2508 9780
Fax: +1(613) 592-4784	Fax: +1(480) 961-1370	Fax: +44(0)1291-430400	Fax: +1(613) 592-7825	Fax: +852 2508 9232

www.mitel.com

For more information on our worldwide office locations, visit our website at www.mitel.com/offices

THIS DOCUMENT IS PROVIDED TO YOU FOR INFORMATIONAL PURPOSES ONLY. The information furnished in this document, believed by Mitel to be accurate as of the date of its publication, is subject to change without notice. Mitel assumes no responsibility for any errors or omissions in this document and shall have no obligation to you as a result of having made this document available to you or based upon the information it contains.

M MITEL (design) is a registered trademark of Mitel Networks Corporation. All other products and services are the registered trademarks of their respective holders.

© Copyright 2008, Mitel Networks Corporation. All Rights Reserved.

